



Appliances that Inspire



www.indurama.com

NA2675



Instruction Manual for use and installation



WARNING: If the information in this manual is not followed exactly, a fire or explosion may result causing property damage, personal injury or death.

- Do not store or use gasoline or other flammable vapours and liquids in the vicinity of this or any other appliance.
- **WHAT TO DO IF YOU SMELL GAS.**
 - Do not try to light any appliance.
 - Do not touch any electrical switch; do not use any telephone in your building.
 - Immediately call your gas supplier from a neighbour's telephone. Follow the supplier's instructions.
 - If you cannot reach your gas supplier, call the fire department.
- Installation and service must be performed by a qualified installer, service agency or the gas supplier.

Congratulations ...

As the manufacturer of your new stove, we would like to thank you for choosing one of our appliances; they are produced with the most advanced technology and meet the highest quality standards.

We have constantly heard suggestions from our customers by introducing the largest number of functional enhancements possible, which allows us to differentiate this stove with its equivalent, ensuring comfort and satisfaction.

Our customer service is always ready to help with a quick and effective solution, if you need parts, repair or warranty.



PRELIMINARY WARNINGS

- THIS GAS STOVE SHOULD BE INSTALLED AND / OR ADJUSTED BY QUALIFIED STAFF ONLY AND THE INSTALLATION MUST CONFORM WITH THE APPLICABLE LOCAL CODES.
- Read technical instructions before installing this gas stove.
- Read instructions before turning on the gas stove.
- Change to a different type of gas should also be done by an installer, the gas company or a representative of our authorized service provider.
- Review the information regarding to this model on the label or identification plate attached to this manual or located in the back of the stove.

IMPORTANT:

- Keep this manual within reach for future reference.
- Complete the Warranty Sheet and save it.



WARNING

- All Ranges can tip.
- Injury to persons could result.
- Install Anti-Tip devices Packed with Range.
- See Installation Instructions.



How to use the instruction manual?

This instruction manual is common for several models with different functions and consists of three parts:

- a) The "Installer's Manual, which contains necessary information for a safe and proper installation of your stove.
- b) The "conversion to different gases" section is only applicable when it is pretending to use a different gas type from that of manufacturer or factory calibration.
- c) The "User's Manual", which contains the operating and safety instructions and also practical recommendations for a proper use as well as the instructions for using each one of the functions of your stove.

NOTE: For a better understanding of the texts, consider that in some countries the gas appliance as we use here, is called "stove" and "grill" is called "broiler."

The following information is very important for your own an others safety important:

This manual and its product have many important safety messages. Always read and follow the safety messages.



This is the safety alert symbol.

This symbol will alert you of situations that may endanger life or cause serious injuries to you and / or to third parties.



DANGER

There is a risk that you may lose your life or cause serious damage if the instructions are not followed immediately.



WARNING

There is a risk that you may lose your life or cause a serious damage if the instructions are not followed.

All safety messages mention what the potential risk is, how to reduce the probabilities of injuries or what may happen if instructions were not followed.

SAFETY ITEMS

- Use two or more people to move and install your product. Failure to do that can cause damage to your spine (backbone) or wounds.
- Always use pipes and pressure regulators according to local regulations. Verify pipes and pressure regulators functionality first and replace them if it is necessary.
- Properly tighten all gas connections during installation. Install your stove according to the specifications described in the instructions manual. Failure to follow these instructions could cause a explosion, fire or damage people's physical integrity.
- Do not use extension cords. Do not use the product without grounding. Do not use T's plug adapters. Unplug the power supply before performing any maintenance on the product. Replace all disassembled components before plugging the product.
- Make sure the feed hose does not cross or come in contact with the back of your stove. If it this is unavoidable, install the flanges which are the accesories included in some models of stoves (check page 6) or use another available device that fullfills the same function. The use of the oven generates hot gases that can damage the hose and presenting serious risks.
- The exterior surfaces of the appliance can reach high temperatures during its operation. Keep away from children and avoid direct contact with the parts that can not be manipulated.
- In case of damage, do not try to solve it by your own. Always proceed to consult an authorized Service Centre or authorized installer.
- Check that the gas burners valves are turned off when you are not using them.

PAG

- 2 INSTALLER MANUAL**
- 4 Installation
- 5 General diagram of Parts and Components
- 6 Gas supply
- 6 Flexible pipe gas connection
- 7 Rigid pipe gas connection
- 9 Power supply

11 CONVERSION TO DIFFERENT GASES

- 11 Change of nozzles
- 12 Primary oxygen regulation
- 12 Reduced power setting
- 13 Safety Tests

14 USER MANUAL

- 14 Burner covers
- 14 Gas burners lighting
- 15 Triple Crown Burner
- 15 Recommendations for using gas burners
- 16 Using the iron fryer
- 17 Mechanical timer
- 17 Touch Pad System
- 18 Digital Timer
- 18 Clock
- 18 Alarm
- 20 Digital thermometer

PAG

- 20 Oven
- 20 Turning on the oven
- 21 Security valve and thermostat
- 22 Short Timer Gas
- 22 How to program an automatic shutdown in the oven
- 24 Triple crown burner
- 25 Turbo System
- 25 Turning on the oven light
- 25 How to operate the electric top
- 26 Recommendations for using the oven
- 27 Parrilla Autodeslizable en el horno
- 27 Turning on the BBQ grill
- 28 Using the rotisserie
- 29 Hotplate
- 29 Precautions
- 30 What to do when you smell gas?
- 31 Avoiding accidents
- 32 Instructions against the incorrect use of your appliance.
- 33 Cleaning and maintenance
- 34 Cleaning function in the touch pad panel

35 PROBLEMS, POSSIBLE CAUSES AND SOLUTIONS

36 GENERAL EQUIVALENTS TABLE

IMPORTANT:

- Manufacturers are not responsible for accidents that may result if the installation and operating instructions are not followed. Also; the guarantee does not cover damage caused by errors in the installation and / or improper operation of your appliance.
- Locate the stove in a room large enough (at least 1.33 m³ per MJ / h of declared rated power of each device installed in the room).
- Make sure the place is ventilated but without strong air currents.
- Keep natural open spaces for air circulation.
- This appliance should not be installed in bathrooms or bedrooms.

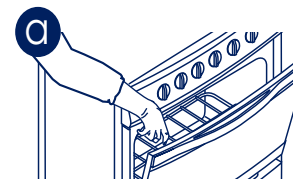

To lift or move your stove, open the oven door, hold from the interior and the section located on the back. Never use the oven handle to lift your appliance.

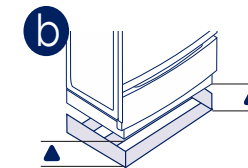

Remove all plastic protectors and foams that only serve while the appliance is being transported.

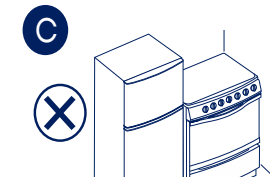

Do not install your stove next to the refrigerator due to heat will decrease the performance of the appliance.

NOTE: If you need to move your stove to any direction, put it on a uniform sheet of plywood which would serve to make the handling. By doing that, you avoid distortions or permanent damage in the stove.

IMPORTANT: Do not allow children to play with covers or plastic sheeting.



WARNING

OVERWEIGHT RISK OF INJURY

Use two or more people to move and install the product. Failure to do so can cause damage to your back or wounds.

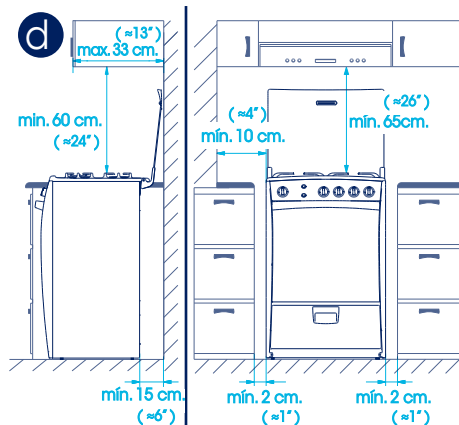

Follow the minimum or maximum dimensions shown in this image.

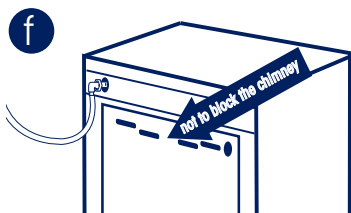

When you install your appliance; be sure not to block the furnace gases exit from the chimney or gills.

NOTE: If your stove has a fixed system or take within fixed accessories, follow the instructions below to avoid accidents with rollovers in your appliances.

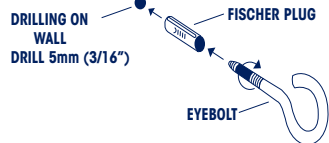

To prevent lodging, the appliance should be anchored to the wall through the fixing system located in the back.

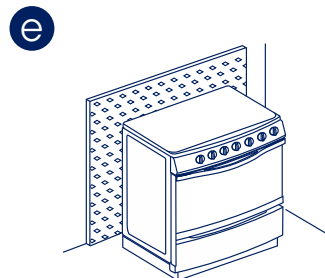

If the stove is going to be installed next to a wooden wall; the appliance must be placed between a fire-resistant material and the wall. With dimensions of width and height which exceed in 4 cm. (≈1.6") to the stove.

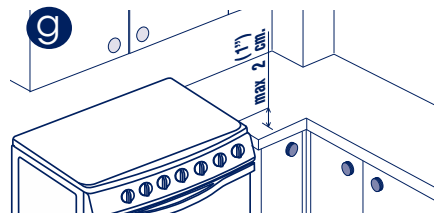

If your appliance has a top closure, comply with the maximum size shown in this picture according to working adjacent surfaces.

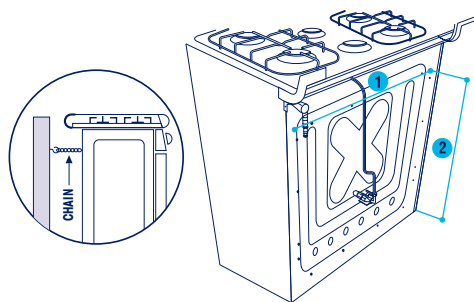

DIMENSIONS FOR DRILLING THE WALL
 1) 770 mm (≈30.3") STOVES 32" 2) 840 mm (≈33")
 570 mm (≈22.5") STOVES 24"
 487 mm (≈19.2") STOVES 20"

Installation:

GENERAL CONDITIONS

- The installation must be carried out by qualified personnel.
- Read all the technical instructions before installing.
- Before installation, be sure local distribution conditions (Nature and pressure of the gas) and gas appliance adjustment are compatible.
- Setting conditions for the gas appliance are located on the back identification label or identification plate:
 - Category I 3, stoves that work only on LPG.
 - Category II 2-3, stoves that can run on LPG or NG.
- This gas appliance is not designed to be connected to a device evacuation combustion products. Its installation and connection should be performed in accordance with the installation standards. Pay special attention to the provisions concerning to ventilation (Reference to Chile: Gas Installations Act No. 66).
- The area where you will install the appliance should include ventilation conditions, as required in the last upgrade Standard NTC 3631 . (Reference for Colombia).
- This device is set to be installed from 0 to 4000 meters above sea level; therefore you do not need to modify it to different local atmospheric pressure conditions and room temperature.
- When installing the stove, it is necessary to comply with the provisions according to NTC NTC 2505 and 3632 Standards (Reference for Colombia)
- Burners output ratings data are founded on the general characteristics sheet attached to this manual.
- In case of adjustments, repair or maintenance of the stove, see the diagram which indicates the general description of the parts and components that must be removed.
- If you need to change the type of gas that will operate the appliance, follow the setting instructions given in the section "Converting to different gases." (It applies only to stove models in the Category II2-3).

- The manufacturer is not responsible for faulty installation that may cause accidents. The gas supply pressure for this stove are:

Ecuador	27.5 mbar = 2.75 kPa (For liquefied petroleum gas LPG use)
Other Countries	28 mbar = 2.8 kPa (For liquefied petroleum gas LPG use) 20 mbar = 2.0 kPa (For natural gas GN use)

Under these conditions, the operation will be the correct one.

General diagram of parts and components.

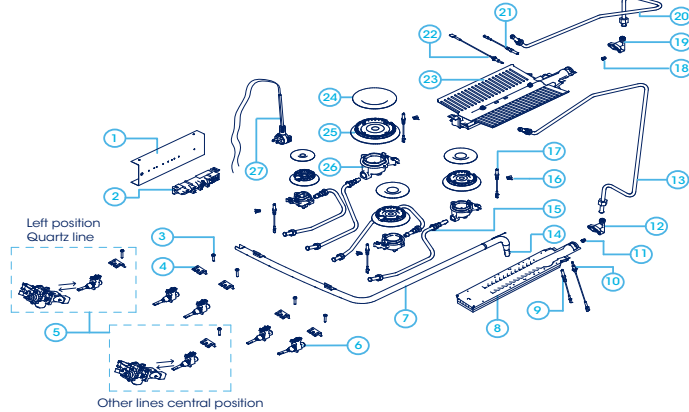

Other lines central position

- | | |
|------------------------------------------|--------------------------------|
| 1.-Lateral generator support | 15.-Mixer pipe panel |
| 2.-115 - 220 V transformer | 16.- Fixation stew clasp |
| 3.- Fixing screw valves and thermostat | 17.- Board stew |
| 4.- Flange valves setting and thermostat | 18.- Grill burner injector |
| 5.- Thermostat / Oven valve | 19.- Grill burner portaciolor |
| 6.- Burner valve panel | 20.- Grill burner pipe |
| 7.- Tub ramp distribution | 21.- Grill burner stew |
| 8.- Floor burner | 22.- Grill burner thermocouple |
| 9.- Floor burner stew | 23.- Grill burner |
| 10.- Floor burner thermocouple | 24.- Burning board caps |
| 11.- Floor burner injector | 25.- Burning board panel |
| 12.- Floor burner portaciolor | 26.- Mixer board cup |
| 13.- Floor burner pipe | 27.- Stove harness |
| 14.- Gas supply | |

INSTALLATION INSTRUCTIONS FOR COVER ACCESSORIES.

- Remove all accessories that packaged in the oven.
- Check the "General diagram of parts and components" to know the names of the components of the device and its location.
- Check burner sizes and select appropriate sizes of bases and end caps.
- Place the burner bases, end caps and grills so that they are firmly seated, without balancing and with proper coupling between the parties, as the items listed below:
 - Make sure the burner base is correctly placed, centered, fixed and the corresponding burner.
 - If your stove has triple crown burner check that the inner end cap is the same size of the central ring.
 - Check that the end caps are centered and fully seated in the burner, without leaving raised on one side.
 - Check the correct settlement moving the end caps slightly from side to side on the burner base until you hear the lock in a fixed position.
 - Check the assembly of components, nothing that when you turn the burner flames are blue, well defined and no strange noises.

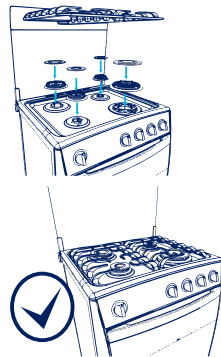

IMPORTANT:

If the placement of the accessories listed is incorrect, there is a risk of accidents or damage to the appliance.

Gas supply



WARNING



RISK OF FIRE

Always use tubing and pressure regulators according to local regulations.

The appliance must be disconnected from the gas supply piping system during any pressure testing of that system. Check the validity of hoses and pressure regulators and replace them if it is necessary. Properly tighten all gas connections during installation. Install the stove according to specifications described. Failure to follow these instructions can cause explosion, fire or damage to people's physical integrity.

Connection to the gas supply with a flexible pipe

IMPORTANT:

- The gas supply must be placed on the same side of the crimp connector (gas outlet) of your stove.
- The gas supply must be made with a flexible suitable gas hose of 8 mm (5/16") or 13 mm (1/2") internal diameter (depending on the gas supply of your stove) and 1.5 to 2 meters length, which carry out the requirements of flexibility, duration and minimum thermal resistance of 70°C (158°F) (Reference for Colombia: NTC 3561. Reference for Ecuador: NTE INEN 885), 60°C (140°F) (Reference for Peru: NTP 300.065.)
- Some countries do not allow the connection to a flexible hose. See respective technical provisions.
- The use of oven generates hot gas evacuation and heats backwards surface which can damage the hose causing serious risks.
- Depending of use conditions of your stove, some zones eventually may reach a temperature of 135°C (275°F). Use a proper connector tube according to the corresponding national installation requirements in force.
- Be sure service cord contacts the back of the stove (hot oven.)
- **Be sure supply hose does not cross or contact the back of the stove, if this is unavoidable, install flanges which are included in the accessories of some models of stoves or use another device for accomplishing the same function. Check the chart for a correct installation of flanges, which are the guiding for the hose, the use of oven generates hot gas discharge that can damage the hose causing serious risks.**

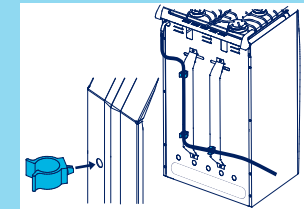

a



If your stove does not have gas outlet: Ask an Authorized Technical Service to provide the respective connector or gas outlet according to the distribution pipe thread (thread 3/8" BSPT or 1/2" ISO 228).

b

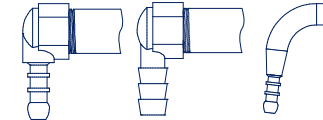

If your stove has gas outlet: The connection of the flexible hose depends on the gas inlet tube and distribution tube and it must be executed by qualified personnel.

Note: Some stoves have accessories included within the gas inlet, the connection must be done by qualified personnel.

INSTALLER MANUAL

Installation and setup

c



Soften the hose edges with hot water.

d

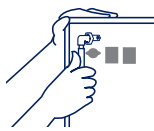

Connect one end of the hose to the gas outlet located at the back of the stove.

e

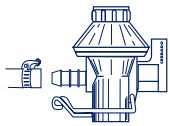

Connect the other end of the hose to the gas cylinder valve or to the gas outlet.

f



We recommend using clamps on all connections to tighten the hose.

NOTE: It is advisable to place the gas cylinder next to the stove.

IMPORTANT:

- The connection should be performed by qualified personnel.
- After you have installed the gas; verify there are no gas leaks, using soapy water around the connection areas.
- Never use flame to verify the presence of gas leaks; it may cause fire.
- The hose must not be bent, tight or close to heat sources.
- In case of problems call to the authorized technical service.

IMPORTANT:

LPG gas cylinders must be installed in places with good ventilation and should not be exposed to heat, electrical sparks, abrupt movements, or spaces where people transit.

Gas supply connection with rigid pipe

Important: All installer manual operations must be performed by qualified personnel.

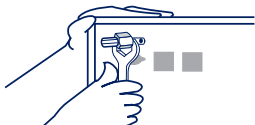

Depending on the distribution pipe thread, dock the threaded end of a female fitting 3/8" BSPT or 1/2" ISO 228 and connect it to the cooper tube to the gas supply. Use sealant products on the device boards, ensuring the application does not obstruct the system.

INSTALLER MANUAL

Installation and setup

ATTENTION:

We recommend to use a new gas installation, observing compliance with standards NTC 3561, NTC NTC3632 and 2505 (Reference for Colombia). Verify the validity of the pressure regulator and connecting tubes.

Connection the natural gas network.

The installation of the products that operate with gas supply network must have the following elements:

1. Distribution Network.
2. Measurement center (measurer and regulator).
3. Service line (pipeline).
4. Valve.
5. Pipeline connection.
6. Artifact.

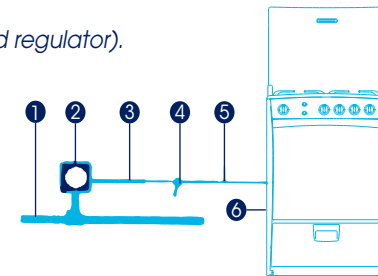

- Check natural gas supply is closed. Remove the cap from 1/2" wich is in the gas.
- Remove and clean sealant particles AVERAGE FORCE that are in the strands of the stoper thread, so that when installing the device they do not obstruct the gas inlet tube.
- Check that the threads of the hose connectors are in good condition.
- Apply the connectors, medium strength sealant for use in gas appliances.
- Perform the coupling between the threads of the gas supply and connecting hose.
- Make the connection between the gas supply hose and the engine. Verify that each of the connectors have its respective packaging.
- Open the gas supply valve and check for leaks using a leak detector, if you not have this device, use soapy water. Do not use matches or lighters for this purpose.
- In the event of leakages, immediately close the valve and check for possible fuel leaks.

IMPORTANT:

Use in the installation, hoses that comply with the material specified in this manual to avoid accidents.

Power supply: All operations in the installer manual must be carried out by qualified personnel.

a

MODEL		TYPE	
COLOR			
V	Hz	Nominal Power	Category
Nominal Pressure		Nominal Thermal Use	

Check on the identification plate which is located in the back of your stove to see the appropriate voltage and power supply for your installation.

b

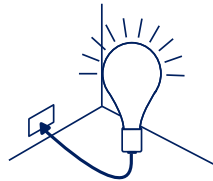

Be sure the outlet is energized by plugging in a lamp and turning it on.

c

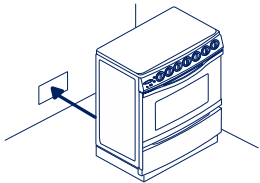

Plug the service cord of your stove to the outlet.

d

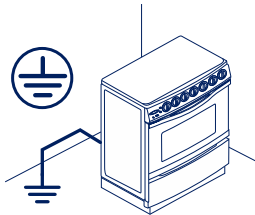

For your safety, when installed the appliance, must be electrically grounded in accordance with local codes. This connection should be performed by a qualified electrician.

e

Be sure service cord never goes near of heat sources and located at the same side of the power supply. In particular consider doors and external surfaces temperature of the appliance may be high when it is operating.

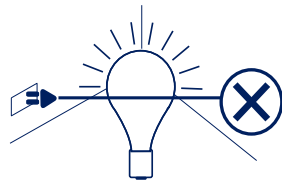

WARNING



ELECTRIC SHOCK RISK

- Do not use extension cords.
- Do not use the product without grounding.
- Do not use adapters or T's.
- Disconnect power before servicing.
- Replace all parts and panels before operating.
- Do not remove the grounding terminal.
- Connect the terminal to an effective ground connection.
- If the power cord is damaged, it must be replaced by the manufacturer, after-sales service, or by a similar qualified personnel to prevent accidents.
- Failure to follow these instructions can bring life-threatening, fire or electric shock accidents.

NOTE: The warranty does not cover problems caused by equipment or defective changes that are not performed by qualified personnel

Electrical installation.

If the appliance has electrical elements, follow the instructions below for installation.

- For some models cooking, take the cable from the back of the appliance and connect it to the grounding installation.

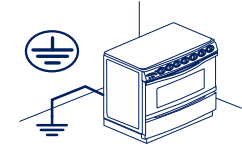

- Make sure the voltage of the outlet connection of the electrical installation is in accordance with the rated voltage of the appliance.

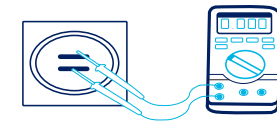

- In the control box of the electric power house, identify the breakers that control the appliance, mark with the name and eventually connect it to the outlet.



IMPORTANT:

If the geometry of the appliance plug does not match the outlet of the installation, change one of them so that both match, ensuring that the plug or receptacle meets the electrical specifications of the engine.

Connectors for wood (In reference).



Flat connector straight (110V)

Three wire connector (110V/220V/240V)

Locked leg type connector (208V/220V/240V)

Connector type C (220V) Valid for Peru



ATTENTION



ELECTRIC SHOCK RISK

The function of the grounding cable is to evacuate the small leakage currents in electrical devices and provide user protection against over voltage short circuit, for kitchens is very important prior connection, which should be the connection circuit to earth on the electrical system of the building or alternatively to a metal water pipe, metal underground structure or local system. Appliances have recessed grounding wire built into current input and require no additional connection.

CONVERSION TO DIFFERENT GASES

IMPORTANT:

- OPERATIONS TO ADAPT YOUR STOVE TO ANOTHER TYPE OF GAS OR OTHER SUPPLY PRESSURE MUST BE CARRIED OUT BY A QUALIFIED INSTALLER, THE GAS COMPANY OR A MANUFACTURER'S REPRESENTATIVE
- For technical and safety reasons, parts for adaptation to another gas family, another group, another subgroup and / or other supply pressure, will be provided by the manufacturer.
- Instructions to "conversion to different gases" applies only to Category II 2-3 stoves (see nameplate), whose factory setting is not appropriate for the gas you

When it is required to convert or adapt to other types of cooking gas, follow the instructions below:

CHANGE INJECTORS:

Burners and oven cover

a

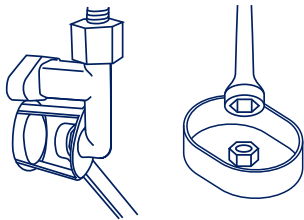

Important: All installation and manual operations must be carried out by a qualified personnel.

For stoves with a injector system, use a wrench or a 7 mm die (9 / 32 of an inch) and remove the nozzle on each burner.

b

According to the type of gas being used, identify on the attached nozzle kit, the diameter for each burner, as indicated in the technical data table burners. (See data sheet)

c

Place the selected nozzles. Do not use thread sealing materials in the injectors.

d

Verify there is no leakage using soapy water at joints.

CONVERSION TO DIFFERENT GASES

PRIMARY OXYGEN REGULATION:

a

The cover burners do not require calibration of primary oxygen.

b

The calibration of primary oxygen of the burners is done as follows:

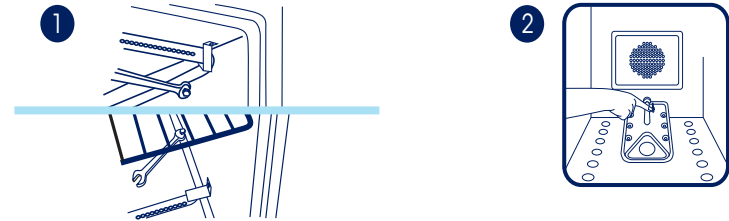

1. Burner Tube:

Turn the calibration bolt clockwise to reduce the amount of oxygen. Counterclockwise to increase the amount of oxygen supplied to the combustion.

2. Burner designs:

Move the hood forward to increase or backward to decrease the amount of oxygen combustion.

NOTE: The burner grill does not require adjustment of primary oxygen

c

Proper calibration is given when the flames are stable and have a deep blue color, indicating combustion is complete.

ADJUSTMENT OF REDUCED CONSUMPTION

Burners and oven floor deck

a

Turn the burner and place the chosen command knob burner in position of reduced power (minimum).

b

Remove the knob and insert a thin screwdriver into the valve stem. (In the case of ovens with a thermostat, the regulation screw is located in the lower part of the stem thermostat.)

c

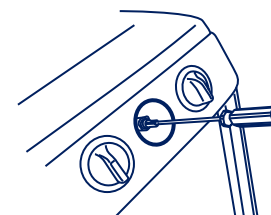

Important: All operations of the installer manual must be carried out by qualified personnel.

Turn the calibration screw inside until you obtain the proper flame, be sure the burner does not turn off when making the respective safety tests.

SAFETY TESTS:

Verifying performance

IMPORTANT:

The following tests should be performed on both cold and hot (after 10 minutes of lighted the oven), and with the specified pressures for each case.

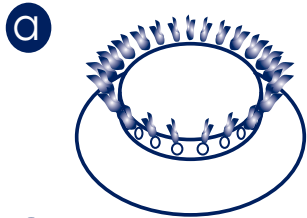

To verify primary oxygen calibration, test the operation of the burners with the maximum and minimum pressures as is shown in TABLE 1.

Verify ignition is easily performed following the instructions in this manual and flames do not show detachment of the burner body and yellow tips, these are signs of a incomplete combustion.



To verify burners minimum calibration performance, test the operation with maximum and minimum pressures as is shown in TABLE 1.

With the burner in minimum consumption position, verify it will not fade with moderate airflow waving with an open palm on the burner. Also verify with quickly movements of the valve from maximum to minimum, if the burner does not turn off or backlash the flame.

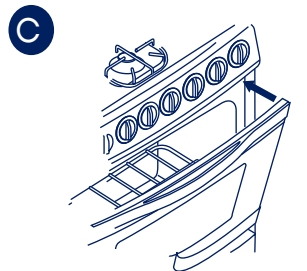

To verify oven burner minimum calibration, test operation with minimum gas pressures as is shown in TABLE 1.

Check in the stop position with the oven door closed only with the tension of the hinge, if the burner does not turn off. Also verify with quickly movements from maximum to minimum if the burner does not turn off or backlash the flame.

TABLE 1

	Ecuador	Other countries	
	LPG (Liquefied Petroleum Gas)	NG (Natural Gas)	LPG (Liquefied Petroleum Gas)
Maximum pressure	33 mbar = 3.3 kPa	25 mbar = 2.5 kPa	35 mbar = 3.5 kPa
Minimum pressure	22 mbar = 2.2 kPa	17 mbar = 1.7 kPa	25 mbar = 2.5 kPa

IMPORTANT: After performing the operations for gas change, a self-adhesive plate included in the kit which indicates cycles and the new setting conditions to which the device has been adapted should be placed. It is recommended to place the plate over the old one so that the information is invalid.

IMPORTANT:

Read all instructions before starting to use the appliance. Refer to the features and functions sheet to identify the ones that belong to the model purchased. Then follow the instructions.

BURNER COVER

Lighting gas burners

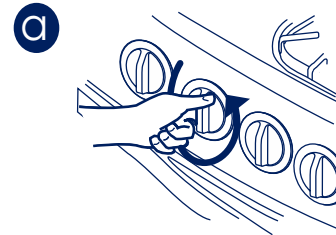

NOTE: It is normal when you operate the electric power, a continuous sparking in all burners.

Choose the burner knob you want to turn on, press and turn counterclockwise to the maximum position (🔥)

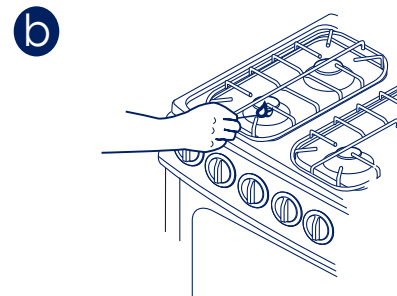

If your stove does not have electronic ignition or in case of blackouts, hold a lit match or lighter to the burner.

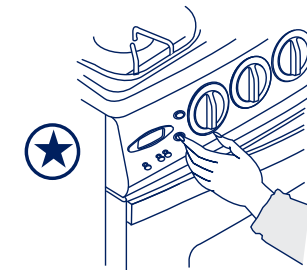

If your stove has electronic ignition, press the switch button and hold it until the burner lights.

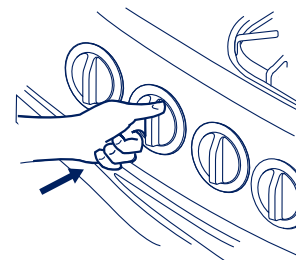

If your stove has electronic ignition from the knobs, press and turn the knob anti-clockwise to the position indicated with the symbol ★, press the knob until you see the burners sparking and the burner will light.

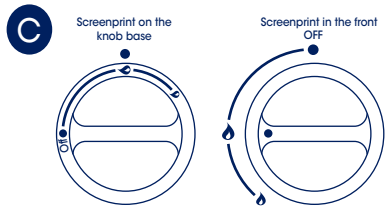

Choose in the knob between MAX (🔥) or MIN (🔥) according to what you are going to cook.

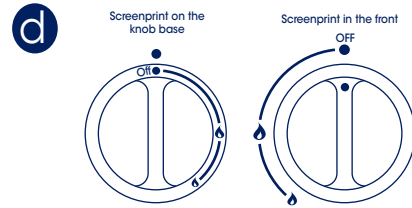

To turn off place the corresponding knob in the position off, which can be represented by OFF or (●).

ATTENTION:

Your stove has tempered glass lid, you should never close it while burners are in use or the oven is being used. Never place hot pots on the glass.

ATTENTION:

In case you accidentally extinguish the flame of a burner, shut off the burner control, ventilate the room and do not attempt to switch it on for at least 1 minute.

Triple Crown Burner (Ultra Fast)

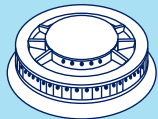

Use this option when you need more power burner flame for faster cooking.

CAUTION: For a proper function; maintain the burner slots and holes always clean.

Recommendations for use of gas burners

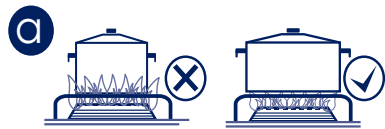

Flame should not extend to the bottom of the pot, pan, etc.

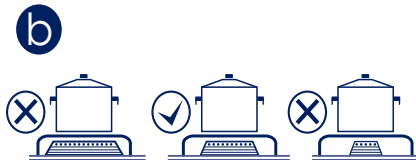

Choose the burner according to the size of container which is going to be used.



In this appliance do not use convex base vessels, except if your stove is equipped with the appropriate accessories for it.

We recommend the following minimum diameters:
 Small Burner - 12cm (4.8") containers
 Medium Burner - 14 cm (5.6") containers
 Large Burner - 18 cm (7.1") containers
 Triple Crown-burner - 20 cm (7.9") container



ATTENTION:

During use and cleaning of the burners avoid food or garbage from entering into them; it could cause a blockage of gas injectors. Remember the correct operation of your appliance depends on the care you give to it.

CAUTION:

- Do not leave empty containers on the burner when it is on, or keep the burner on when not in use.
- Do not handle burners immediately after use, they retain heat for several minutes after switching it off.
- The glass lids can explode when it is heated. Turn off all burners before closing the lid.

Use of iron fryer Iron fryer with docking board.

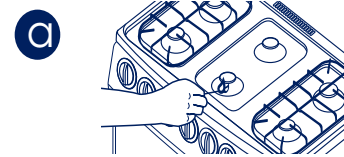

Remove the surface burner grate and replace it with the griddle, then turn on the front and back burners under the griddle.

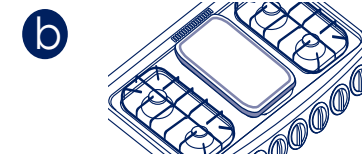

Make sure the griddle is placed correctly before using.

Iron fryer with coupling grill burners.

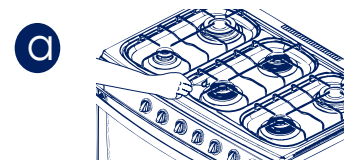

Turn the front and back burners where you are going to use the iron fryer and set them at a minimum position.



Place the plate over the grills; verifying that it is embedded in the slots in the back of the iron, so it will not slide excessively on the grill.

IMPORTANT:

The iron should be used in preference over burners of the same size; in any case it should always operate in a low position. (Reduced consumption)

RECOMMENDATIONS:

- When using the grill, it should be preheated over burners in the minimum position and then smear it with an absorbent cloth soaked in oil or another fat.
- If you use the grill for meat it must be continuously spread with oil while turning around the food to avoid that the liquid from staining iron surface.
- Never introduce the iron into a water stream while it is still hot.
- Do not use abrasive pads or sharp objects for cleaning; this can cause damage to the teflon.

MECHANICAL TIMER

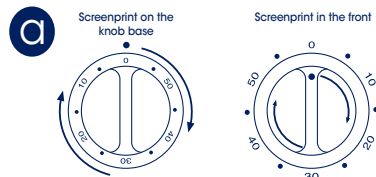

Turn the knob clockwise until you reach the time required (up to 60 minutes).

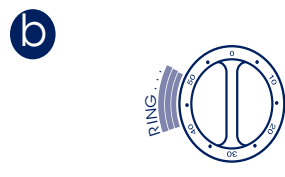

When time reaches the alarm will sound, indicating that the food is ready.

TOUCH PAD SYSTEM

The touch pad system is a modern digital system that allows you to program the functions of your stove by touching the controls without pulsating mechanics. The system has a security lock to prevent inadvertently changing the clock setting or accidentally programming or activating other functions.

In this system, lock is automatically activated when the controls have not been touched for more than 5 seconds. To unlock you have to activate the controls hold one of them for 2 seconds, then a simple touch will be enough for their use.

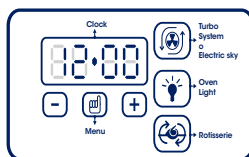

In this system, the lock is activated by pressing the menu control (Menu) to the note that the lock icon is lit in blue (lock icon), press control (+) appears on your screen and the words "Lock On" and the icon changes to red color. To remove the lock, hold pressing controls (+) and (-) together, until you see on your screen the words "Lock OFF" and the icon changes to blue

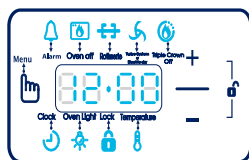

NOTE:

These icons indicates the characteristics of the TouchPach which are not pulsated for operation or programation.



IMPORTANT:

- Keep always clean and dry the system control panel and the front of the stove in general. The correct operation of the appliance depends on this, while avoiding damage to your stove misuse.
- The liquid spill on the control panel or cleaning with wet pads can activate the Touch Pad. In this case, wipe the panel, review the functions and activation and reprogram it if is necessary. To clean, follow the instructions shown on page 30. For a light cleaning, the use of a dry paper towel is recommended.
- Before any programming clock, the control lock must be removed.
- Time programming, alarm or gascuts is recorded and automatically locks in 5 seconds if any other impulse is not done.

DIGITAL TIMER

The following instructions describe the use of various types of clock (digital timer) which have different stove models. Identify the one belonging to your appliance and follow the instructions.

When connecting your stove you will notice flashes of characters on the clock screen until any programming is done.



Clock

Touch Pad System

In this system to set the time, take several long pulses (3 seconds) in the control menu (Menu) until you notice flashing at the point that divides hours from minutes, then set it by pressing the controls (+) to go upward and (-) to go downward.



If your kitchen has this system to match the time, press the menu control (Menu) to see that the clock icon (clock icon) lights up in blue and appear on your screen the words "clock - SET clock", then even pressing controls (+) to go ascending and (-) to go in descending order, the icon will turn red. Finally press the menu control again until no icon does not light



Pulsed System

To set the time, press once the first button on the left (Clock icon), then press the button corresponding to the symbol (+) to move upward, and the button that corresponds to symbol (-) to move downward.



Pulsed System (short gas system clock)

If your stove has a short gas system, simultaneously press (+) and (-) buttons until you observe intermittency at the point that separates hours from minutes. Then set it by pressing (+) to move upward and (-) to move downward. The setting will be saved after 7 seconds of the lasted press of the key.



Alarm

Touch Pad System

Press and hold (3 seconds) the menu control until you see a bell icon (bell icon) blinking in the bottom of the screen.



Press (+) or (-) controls to set the time the alarm will sound, starting from 10 seconds to 10 hours (after 99 minutes display changes to hours). Consider that the advance of time change in intervals of 10 seconds. After 5 seconds the time countdown will automatically start on the clock display, minute by minute. At end of the scheduled time the alarm will sound every 15 seconds for 5 times.

Press de menu control to observe a bell (🔔) blue lighting on the front of your kitchen and appears on the display the word " ALAr ". Press the controls (+) or (-), the icon will change color to red to set the time the alarm sounds, from 1 minute to 24 hours. Consider the progression of time that program changes in 1 minute. After 5 seconds automatically start the countdown time clock display, minute by minute. At the end or the programmed time the alarm will sound for 10 minutes, after this time the flash icon appear on your screen and the word " ALAr " until you turn it off by pressing the control menu (🍽).

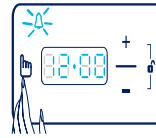

Pulsed System

Press directly the button corresponding to (+) symbol and a light will be displayed on the screen (🔆) or (●).

Set the alarm by pressing the button which corresponds to the sign (+) to move in ascending

order and the button that corresponds to the sign (-) to go downward.

Select the required time starting from 10 seconds to 99 minutes. You will automatically see the countdown time on the display second by second. At the end of the scheduled time the alarm will sound.



IMPORTANT:

Before setting the alarm, you must ensure that buttons were not touched at least one minute before.

Pulsed System (gascuts system clock)

If your stove has gascuts system, the alarm is linked to short gas timer to program it follow the instructions given on page 19.

Turning off the alarm

1.- Touch Pad System

To deactivate the alarm hold up control menu until you see bell imagen (🔔) turns off.



To deactivate the alarm press the menu control to observe a bell (🔔) going on in front of your kitchen and appears in the word " ALAr " screen, then use the control (-) down to 0 minutes.

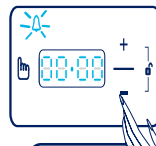

2.- Pulsating System

To deactivate the alarm press boton corresponding to the symbol (+).



How to visualize the time?

1.- Touch Pad System

To visualize temporarily time while alarm is activated, press control menu (🍽) without removing lock.



2.- Pulsation System

To visualize time when alarm is activated, press once boton from left side (🔆).



Digital Thermometer

This function is only applicable for some types of stoves with Touch Pad system, it allows visualize food cooking temperature inside of teh oven.

How to visualize temperature?

To visualize temperature inside teh oven , press control menu (🍽) without removing the lock., this function deactivates automatically after of de 5 seconds.



In this system, to display the temperature inside the oven, press the menu control (🍽) until the icon temperature turns blue (🔆), the temperature in °C appear on your screen , if you want to switch to °F press the control (-) there of are displayed on a scale of 5°. This turns off automatically after 10 seconds.

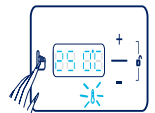

IMPORTANT:

If your stove has digital thermometer the temperature showed in the display is not used as reference when you are using grill, because this function is only applicable for baking.

OVEN

Turning on the oven

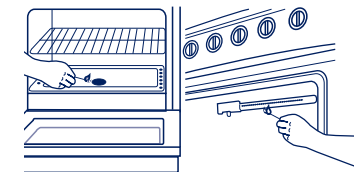
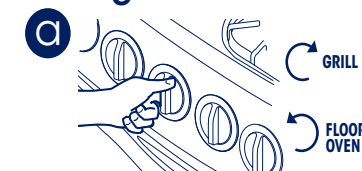

1. Stand in front of the oven control knob , press and turn it counterclockwise to the maximum temperature position to turn on the oven burner, or clockwise to the grill position (if you have this function), as you need.

2. If your stove does not have electric ignition, hold a lit match near the oven burner duct (bottom front) or directly to the burner grill, as you need.

3. If your oven has electronic ignition, press the switch and hold until the burner lights.

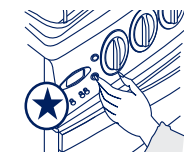

In the absence of Electricity:

Remove the burner tray cover (lift slightly the front of the tray and pull it out), light a match and keep it close to the oven burner holes, finally open the gas flow from the corresponding knob. After verifying the right placement, check on the tray again to make sure it is fully seated and reaches the back of the oven.

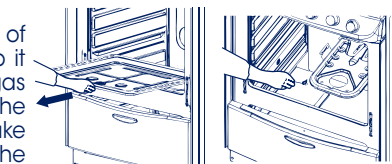

4. If your oven has safety valve or thermostat (Oven Safe), follow the instructions given on page 21.

IMPORTANT

The electronic ignition is common for burners and oven cover, therefore it is normal to see sparks in the burners when turning on the oven.



WARNING



RISK OF FIRE

Make sure the oven burner is lit, looking through the holes found on the bottom plate of the oven burner covers. We recommend opening the oven door to verify this point.

b

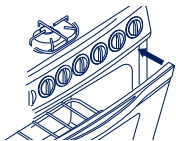

Close the door softly to bake. For better results when browning, preheat oven for 20 minutes or more on the MAXIMUM temperature position before baking. Select on the oven temperature knob according to what you are going to bake.

c

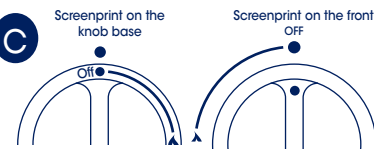

To turn off place the knob in the off position, which can be represented as OFF (●).

IMPORTANT:

When using the oven for first time, keep it on for several minutes to remove odors and gases which are normally produced. In the case of accidental extinction of the flames from the burner, close knob and do not restart after at least 1 minute.

ATTENTION:

Accessible parts such as doors or exterior fixture surfaces can reach high temperatures when the appliance is in use, especially when using the oven or grill. Keep away from children and avoid direct contact with the parts that are not manipulated.



WARNING



RISK OF FIRE

Make sure the gas valves from the burners and especially from the oven are closed when not in use, as gas can accumulate and cause explosion and when activating the electronic ignition.

Security valve and thermostat (Safe Oven)

This mechanism prevents accidental release of fuel gas in the oven (floor and grill), avoiding risks during its use.

Turning on the Oven Safely

1.- Stand in front of the oven control knob, press and turn it counterclockwise to the maximum temperature position to turn on the oven burner, or clockwise to the grill position in the case of thermostat, as you need.

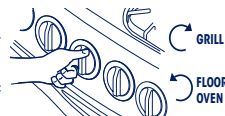

2.-In models with a security thermostat, the electronic ignition is done directly from the knobs, so you must hold down the knob for at least 10 seconds until the sensor detects the presence of flame in the oven and the burner will remain on.

3.-On models with safety valve and electronic ignition, after ignition, press the knob for at least 10 seconds until the sensor detects the presence of flame in the oven, this way the burner will remain on.

In the absence of electricity, remove the cover-burner tray (slightly lift the front of the tray and pull it out), light a match and keep it close to the burner holes, finally open the gas flow and hold down the knob as indicated above. After verifying the right ignition, make sure the tray is completely seated and that reaches the back of the oven

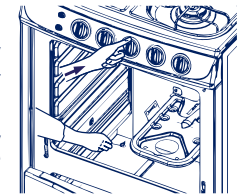
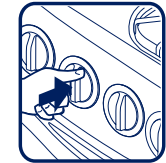

WARNING



RISK OF FIRE

Do not activate the ignition over 15 seconds to avoid gas accumulation. If after this time the burner does not light, the operation must be stopped and the oven door opened; waiting for at least 1 minute before attempting to relight the burner.

Short Timer Gas

It is a system which automatically shuts off the burners and grill of the oven floor and Triple Crown in certain models of stoves after the time set by the user, allowing prepare food without risk of burning.

Note for models with "Timer Gascuts"

If the event of an electric shutdown, the triple crown burners will shut down automatically closing the gas flow although the knob is in any position of the thermostat or security valve. You can relight the burner if required even though electricity is not available, then you need to use a match as shown on page 20 for oven and page 24 for triple crown.

IMPORTANT:

Before using the oven or the triple crown with short gas timer, set the digital clock according to the instructions given on page 18.

How to schedule automatic shutdown in the oven

Touch Pad System



Once the oven is turned on (check thermostat safety), make several long pulses (3 seconds) in the menu control until you see the (🔒) or (🕒) symbols at the top of the screen.

Press the controls (+) or (-) to set the time required for the automatic shutdown of the oven, from 10 seconds to 10 hours (after 99 minutes the display changes to hours). Consider that the advance of time in the program changes in 10 seconds intervals. After 5 seconds it will automatically start the countdown minute by minute.



At the end of time, the oven will shut off and the alarm will sound at intervals of 15 seconds for 5 times.

Touch Pad System.

After turning on the oven (I revise safety thermostat), press the menu control () repeatedly to see that the symbol () lights blue and display "OVEn" on the front of your kitchen. Press the controls (+) or (-) and the icon will turn red, to schedule the time required for the automatic shutdown of the furnace, from 1 minute to 10 hours. Consider the progression of time that program changes in 1 minute. After 5 seconds automatically start the countdown time.

At the end of the scheduled time the oven will turn off and the alarm will sound intermittently for 10 minutes until you press the menu control (). Furthermore, if the focus oven functions and BBQ were burning engine, they too will go.

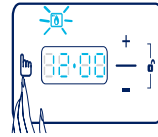

Pulsed System

Once the oven is turned on (check instructions on the Safety Valve) press the button corresponding to the () symbol and the word (AUTO) will be displayed on the left side of the screen.

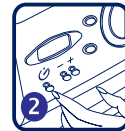

Set the sleep time by pressing the button corresponding to the (+) symbol to move upward and the button for (-) symbol to move downward. Select required time starting 1 minute to 10 hours. Countdown will automatically start minute by minute.

At the end of time, the oven will shut off and alarm will sound.



How to shut down the gas alarm.

1.- Touch Pad System.

To deactivate the alarm or restart the oven press the menu control until the symbols () o () disappear from the screen.

2.- Pulsating System.

To turn off the alarm press the button corresponding to the () symbol.

How to deprogram?

To turn off the alarm system and the automatic gas cut off, reduce the time scheduled until you reach zero.



How to display the time or temperature in the oven.

1.- Touch Pad System

Depending on the type of touch pad your stove has, you can temporarily display the time or temperature while the gascut programming is activated, press the menu control () without removing the block.

2.- Pulsating System.

During the scheduled time, time will be displayed. If you wish to visualize or change the remaining time until shut down, press the () button.



Triple Crown burner Security (Security Valve)

Turning the Triple Crown burner safely

1.- Stand in front of the oven control knob, push and turn clockwise until you reach maximum temperature position.

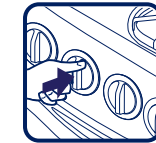

2.- On models with a safety valve on the triple crown burner, the electric ignition is direct from the knobs, therefore you must hold down the knob for at least 10 seconds until the sensor detects the presence of flame, this is the only way the burner will stay on.

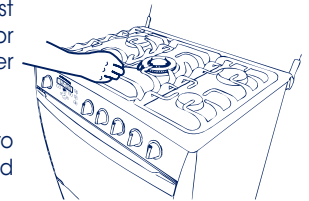

In the absence of electricity, light a match and keep it close to the triple crown burner holes, open the gas flow and hold down the knob as indicated above.

How to program the automatic shutdown of the Triple Crown burner Safely



Once the triple crown is on, press the menu button until the symbol () is shown at the top of the screen.





Press the controls (+) or (-) to set the time required for automatic shutdown of the burner, from 10 seconds to 10 hours (after 99 minutes the display changes to hours). Consider that time advance changes every 10 seconds. After 5 seconds, countdown will start automatically minute by minute.

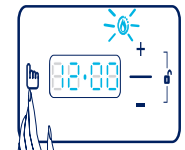

At the end of scheduled time, Triple Crown burner will turn off and the alarm will sound in intervals of 15 seconds for 5 times.

For this control touch pad, once on the triple crown (I check valve safety instructions), press the menu control () several to see that the symbol () blue lights and displays the words "TRIPLE Cr bUrner" in the front of your kitchen. Press the control (+) or (-) and the icon will turn red, to schedule the time required for the automatic shutdown of the burner, from 1 minute to 10 hours. Consider the progression of time that program changes in 1 minute. After 5 seconds, automatically start the countdown time.



At the end of the scheduled time the burner will turn off and the alarm will sound intermittently for 10 minutes until you press the menu control ().

How to Cut off gas alarm.

To deactivate the alarm or to restart the triple crown burner, press the menu control until the () symbol disappears from the screen.



How to deprogram.

To turn off the alarm system and gas cut off from the Triple Crown burner, reduce the time until you reach to zero.



Turbo system

This system allows a better cook in the oven by applying a forced circulation of hot air, obtaining a uniform baking and subsequent an increase in heat.

How to use

IMPORTANT:

When placing food, avoid gluing to the bottom of the oven so not to block recirculation air holes that are facing the fan.
The turbo system is designed to use only with the floor burner of your stove, do not use the grill burner.
It is recommended to preheat the oven before turning on the turbo.
This system allows you to bake 2 grids simultaneously.

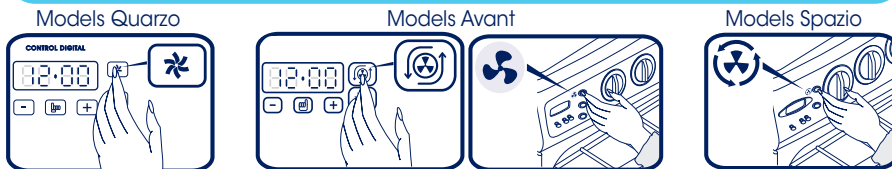

Locate and press the corresponding switch to turn on or off the turbo system fan that is located at the bottom of the oven.

For this system touch pad, press the menu control (), until the turbo icon () lights up in blue and display "turb", press control (+) icon will turn red and turn the turbo, to turn it off press control (-).



Turning on the oven light

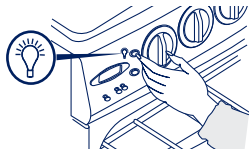

Locate the corresponding switch and activate it to turn on or off bulb from inside the oven.

For this system touch pad, press the menu control () until focus icon () lights up in blue and display the words "OVEn LiGht" press control (+) icon will turn red and turn the oven light, to turn it off press control (-).



How to operate the electric sky

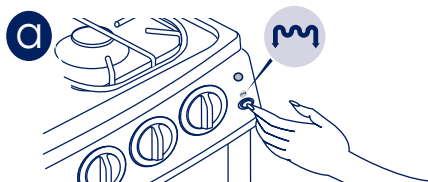

Locate the corresponding switch to turn on or off the electric sky found in the top oven.

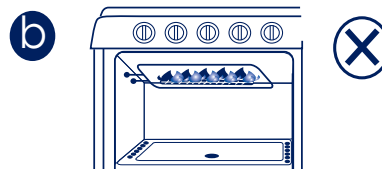

The electric sky and the grill / BBQ should not be used at the same time.

For this system touch pad, press the menu control (), until the electric sky icon () lights in blue, press control (+) icon will turn red and turn the electric sky, to turn it off press control (-).

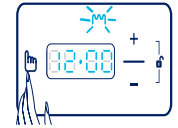

IMPORTANT:

We recommend using the electric sky with floor burner to obtain an even cooking and better browning of food.

Recommendations when using the oven

- a Always preheat your oven at the MAXIMUM position for 20 minutes or more. This is important to achieve a fast and uniform cooking.
- b The height of the tray or the grill, as well as the use of the accessories and functions of the oven depends on the food to be baked, but we recommend:
 - 1) Use the grid on the third slide (from the bottom above) for baking bread, cakes, etc.
 - 2) For cooking meat use the third slide (from the bottom above), whether you use the oven burner or grill to brown.
- 3) If your stove model has not electric sky or grill, use the third slide (from the bottom above) for browning the baked food.
- 4) Follow the recipe instruction properly.
- 5) To bake bread, cakes, arepas, cookies, pizzas or similar food, we recommend use a baking plate on the grill.
- 6) Do not place on the grill or oven trays above the recommended weight:
 - Stove 20" = 20 pounds (9 kg)
 - Stove 24" = 22 pounds (10 kg)
 - Stove 32" = 30 pounds (14 kg)
- 7) For greater uniformity in baking use the turbo system (models with this function.)

ATTENTION:

When baking on the grill, remember to remove the middle tray from the oven. Food should not be baked directly over tray, or without it.

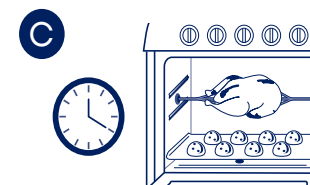

The cooking time will depend on the food you are baking, the amount and the temperature selected; recipe books can be taken as reference.

Autodeslizable grill in the oven

IMPORTANT:

If your stove has autoslide grill, it only operates on the second slide, if you need to place the grill to another level remove the facility as indicated:

Mechanism with central rod.

- a** Press the edge inward.
- b** Lift the grill mechanism and remove.
- c** To reset the latching mechanism on the grill first and then insert in the oven door.

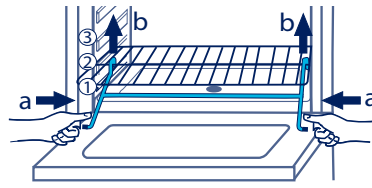

Individual mechanisms.

- a** Lift mechanisms simultaneously and remove the oven rack.
- b** Lift and turn mechanism for removal.
- c** To reassemble first place mechanisms from the right side and place them into the oven, then enter the grid and simultaneously coupling mechanisms.

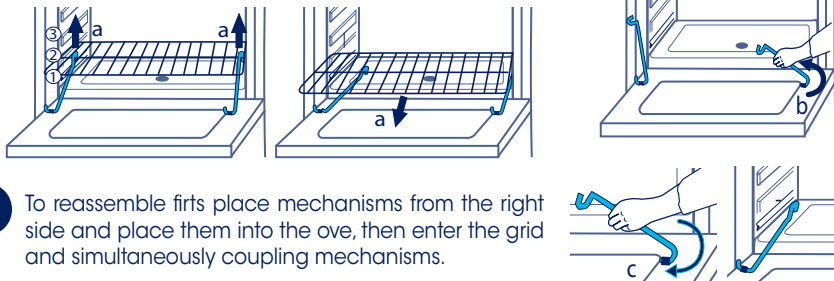

For cookers 4 burners, 20" and 24", hitch mechanisms in the central rod of the grid. For cookers 5 or 6 burners, 32" hitch mechanisms rod on the back of the grid.

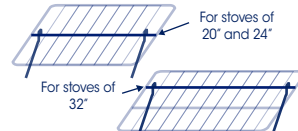

Turning on the BBQ grill

NOTE: If you require roasting or grilling after baking all kinds of meats use the grill / broiler.

ATTENTION:

The electronic ignition is common for burners and oven cover, therefore it is normal to see sparks in the burners when turning on the GRILL.

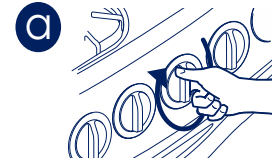

Stand in front of the grill control knob (oven) and turn on following the instructions given on page 20 "Turning on the Oven".

If your stove has a safety thermostat follow the instructions on page 21 "Safe Oven."

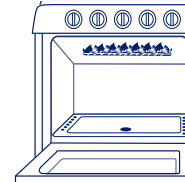

ATTENTION:

We recommend opening the oven door to verify the GRILL has turned on in both the front and back burner.



Close the door gently when roasting or browning.

ATTENTION:

Accessible parts may become hot when using the oven or grill. Keep away from children and avoid direct contact with the parts that are not manipulated.

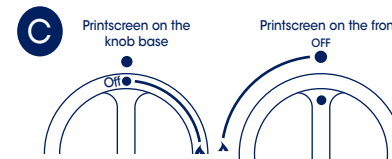

To turn off place the knob in the off position, which can be represented as OFF (●).

WARNING



Make sure the gas valves from the burners and especially from the oven are closed when not in use, as gas can accumulate and cause explosion and when activating the electronic ignition.

Using the rotisserie (Spiedo)

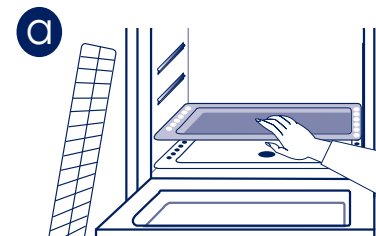

Remove the grill and place the tray oven.

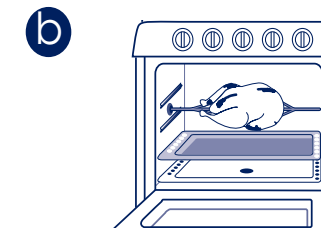

Place the chicken on grill and secure the rod using the fork, then install the rod inside the oven, introducing first the left end and then the right one.

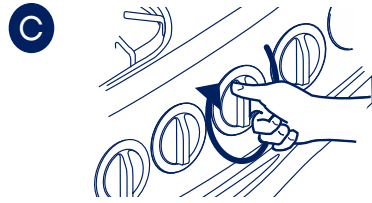

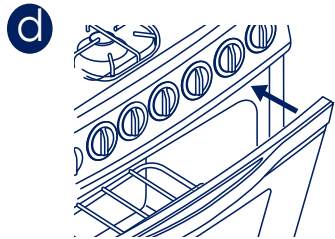

Turn on the broiler / grill as indicated on page 21



Close the door gently to roast.



Locate and press the BBQ switch, which also turns on the oven light.

For this system touch pad, press the menu control (), until the BBQ icon () lights up in blue and display the words "roASTEr". Press the control (+) icon will turn red and turn the BBQ, to turn it off press control (-).



HOT DISHES

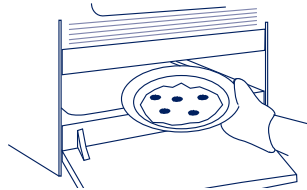

When using the oven, you can use the hot plates to keep food hot, for grilling or preheating dishes before serving.

PRECAUTIONS

WARNING



RISK OF FIRE

Do not use this appliance as a heating element and high temperatures generated in the components that can cause burns to you or your loved ones. Do not use this appliance as a storage area as heat storage materials can generate liquids or gases that originate combustion. Do not stand or lean on the oven doors and / or hot dishes as it may cause, tipping of the stove, permanent damage to the components thereof or burns from heat generated during operation.

ATTENTION:

The use of a gas cooking appliance produces heat and humidity in the room where it is installed. A good ventilation should be assured in the kitchen; maintaining natural ventilation, or installing a mechanical ventilation device (extractor hood). The intense and prolonged use may require a ventilation unit, for example, opening a window, or more effective ventilation for example, increasing the power of mechanical ventilation, if any.

What do you do if you smell gas?

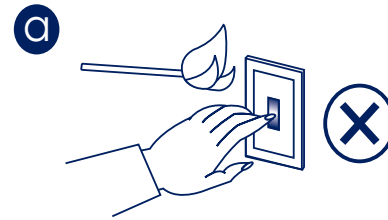

Never turn on any type of housing switch on the kitchen. Do not use matches, lighters or any other object that generates combustion.

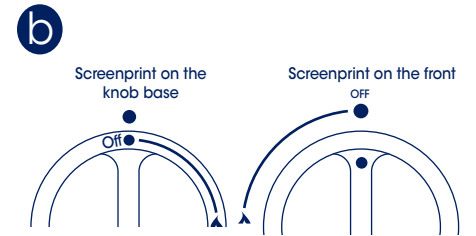

Place all knobs in off position, which can be represented by OFF or (●).

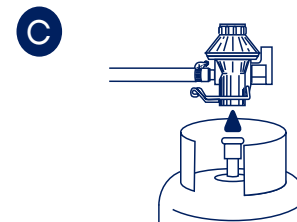

Close and / or disconnect the gas connection on your appliance.

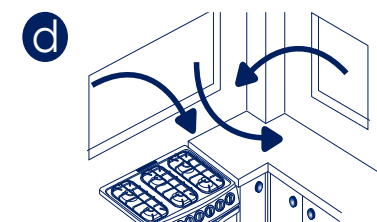

Open doors and windows to get air circulation.

PROBLEM	POSSIBLE CAUSE	SOLUTION
Smell Gas	Drilling pipe or hose connection.	Change the installation
	Incorrect position of the burners	Place them in the correct position.
	A burner turned off accidentally while still in use	Call technical service
Strong odors	Pressure regulator installed incorrectly	Install it correctly
	Oil and grease used in the manufacturing of your stove	It is normal when using the stove for the first time
Noise	Expansion of metals due to heat	It is normal

Check the possible causes and solutions described on page 35.

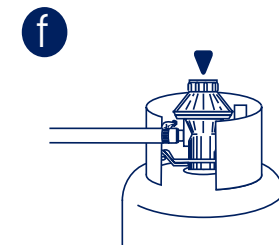

Open and / or reconnect the gas connection.

! WARNING



If the gas smell persists, close and / or disconnect the gas connection and call authorized technical services. Failure to follow these instructions can cause explosion, fire or damage to physical integrity of persons.

Avoiding accidents

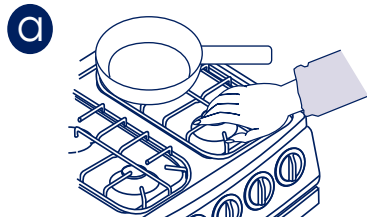

While cooking with cover burners, avoid touching the racks, burners bases and end caps, wait a reasonable period of time for cooling.

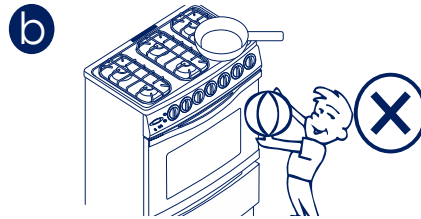

! BE CAREFUL WITH CHILDREN !

Avoid the following situations from occurring:

- The entry of children into the kitchen while cooking.
- Outgoing handles from pots and pans.
- Children being close to kitchen utensils (pots, hot springs, etc.).

! WARNING



Make sure the gas valves from the burners and especially from the oven are closed when not in use, as gas can accumulate and cause explosion and when activating the electronic ignition.

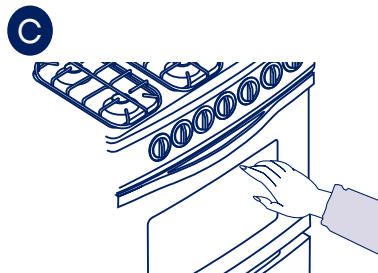

While using the oven, avoid touching the glass, internal peripherals and wait a reasonable period of time for cooling and handling.

d

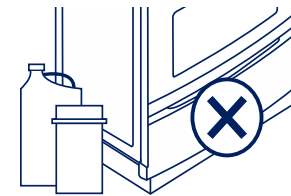

Do not store gasoline or other similar product near your stove.

NOTE: When using the oven, it is advisable to use gloves when handling food containers that are baking.

IMPORTANT: Be careful with the oil and frying fats which are inflammable products. In case a fire presents due to this reason, turn off the burner and control flame by placing a large pot lid over it or covering the fire with a wet cloth. Never throw water directly as the flame grows and can cause fire or burns.

If grease fire occurs in the oven, turn off the burner and keep the oven door closed until the flame is extinguished on its own. Prevent these problems by removing excess fat and avoid from it being close to the oven burner.

Instructions against misuse of your stove

- Make sure the kitchen is well ventilated and maintain natural open spaces for ventilation.
- This device should not be installed in bathrooms or bedrooms.
- Install the device according to the instructions in this manual .
- The use of this appliance is domestic, do not use it for any other activities.
- Follow the instructions in this manual to operate each function on the appliance.
- In case of damage, do not try to solve on your own. Always go to an authorized technical service.
- Do not use any protection on the board (foil), this could cause blockages in the gas outlet nozzle or a bad coupling of the burner parts.

CLEANING AND MAINTENANCE FOR THE USER

IMPORTANT: Clean regularly your stove components to avoid permanent stains or chemical attack due to food waste, especially on the stainless steel surfaces.

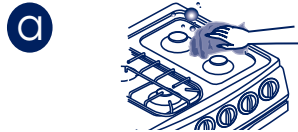

- For cleaning all surfaces use a soft pad with soapy hot water and bicarbonate (2 spoons in a liter of water.)
 - To clean the burner cap and burners base use a plastic brush with soft bristles for not damaging the stove finishes.

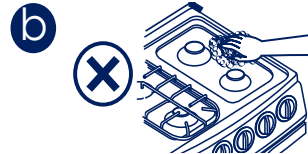

- Do not use corrosives or hard abrasive products which can deteriorate finishes and shine.
 - To prevent smudging do not leave residues of cleaning agents in the surfaces and dry them thoroughly.
 - In stainless steel surfaces make cleaning in the same direction of the surfaces finishes.



- Do not use detergents, aerosols, corrosives or harsh abrasives products which can deteriorate the stove finishes.
 - Do not use chlorine or chlorinated products in the surfaces of stainless steel to prevent corrosion by etching.

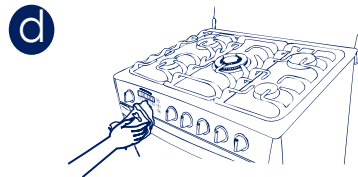

- To clean glass fronts and system control panel touch pad is suggested to use a dry paper towel.
 - To prevent smearing mustard do not leave residues in the chrome surfaces, or satin nickel.
 - Keep the electronic ignition slides clean and dry.

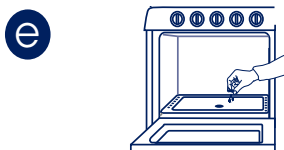

For removing charred food residues, you can use lemon juice.

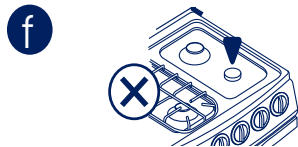

IMPORTANT: When you clean the board or burners should be careful not to introduce food waste in the crown, or worst in the injectors.



IMPORTANT: When placing burners and end caps after cleaning them, make sure they were in the correct position and completely dry.

WARNING: Damage caused by the lack of these instructions is not covered by the warranty.

CLEANING ROLE IN TOUCH PAD PANEL.

IMPORTANT:

This service allows you to clean the touch pad panel of your stove without activating the functions involuntarily (update time, timer, wake light, etc.).

ACTIVATION:

Simultaneously press the signs (+) y (-) of the clock and maintain the contact for more than 5 seconds until to note the word "ASEO" (Clean in Spanish) appears intermittently, then press menu to activate the function with the word aseos remaining fixed in the screen. In this way you make the stove cleaning for a period of 5 minutes without activating the various functions run from the touch pad panel.

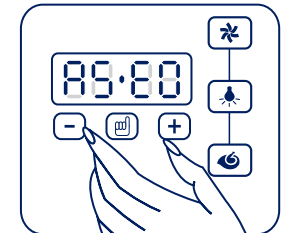

IMPORTANT:

Note that when activating the cleaning mode, all functions of the stove commanded from the touch pad panel are blocked, even if they were in use. Cleaning is recommended doing when not using the digital command functions of your stove. The system reactivates automatically after 5 minutes, which are assigned for cleaning, enabling once again all features.

You can repeat the cleaning operation as many times as necessary.

To cleaning, in touch pad system, use lock function by following the instructions on page 17 of this manual.



IMPORTANT: If after reviewing the possible causes and solutions the problem persists, call an authorized service agent.

PROBLEM	POSSIBLE CAUSE	SOLUTION
Smell Gas	Drilling pipe or hose connection.	Change the installation
	Incorrect position of the burners	Place them in the correct position
	A burner turned off accidentally while still in use	Call technical service
	Pressure regulator installed incorrectly	Install it correctly
Strong odors	Oil and grease used in the manufacturing of your stove	It is normal when using the stove for the first time
Noise	Expansion of metals due to heat	It is normal
Electrical components do not work	Stove off Outlet not energized	Connect the power cord Check plugging in a lamp to see if outlet is energized
Floor and grill do not work at the same time	It is not possible turn them both at the same time	Read the instruction manual
Yellow flame makes soot	Gas almost over The burners position is not correct	Change gas cylinder Place burners in the right position.
When turning on the light, the bbq rod works		This is normal
Decreased flame intensity on the burner cover	Injectors blocked by food waste	Clean the nozzles using plastic bristle brush without excessive pressure on nozzle walls
The floor and grill burners and the Triple crown remain on. (Just stoves with thermostat and / or Safety valve)	The flame sensor does not detect the presence of it. The presence of it. The action time is not enough.	Keep the knob press down for 10 seconds while the device is powered (electronic or matches)

TABLE OF GENERAL EQUIVALENTS

Common Measures		Liquid Measures	
1 pinch	less ¼ teaspoon	8 tablespoons	½ cup
3 teaspoons	1 tablespoon	1 cup	8 liq. Ounces
2 teaspoons	30 gr = 1 ounce	1 cup	1/4 Liter
4 teaspoons	1/4 cup	2 cups	1/2 Liter
8 teaspoons	1/2 cup	3 cups	1 bottle = 750 c.c.
12 teaspoons	3/4 cup	4 cups	1 Liter = 1.000 c.c.
16 teaspoons	1 cup		

EQUIVALENT OF FAHRENHEIT DEGREES IN CELSIUS DEGREES

122° F = 50° C	250° F = 121° C	400° F = 204° C
130 54	275 135	425 218
150 66	300 149	450 232
175 79	325 163	475 246
200 93	350 177	500 260
225 107	375 191	

TECHNICAL SERVICE

If you have a problem you can not solve with the help of this manual; visit or call an authorized service agent. Skilled technicians will teach you everything you need to know to correctly use your stove and in case your appliance malfunctions, they will solve your problem.